

# UPPER ARM AUTOMATIC CELLULAR BLOOD PRESSURE MONITOR

iBloodPressure®

## INSTRUCTION MANUAL

Model: SMBP-LD-575-001



### PARTS AND COMPONENTS

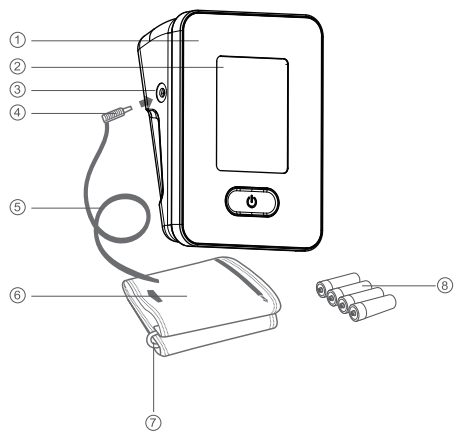

1. Main Body
2. LCD Display
3. Air Connector
4. Tube Plug
5. Air Hose
6. Cuff
7. D-ring
8. Batteries

### SYMBOLS

Symbols	Meaning
	Manufacturer
	Authorized Representative in the European community
	The device, accessories and the packaging have to be disposed correctly at the end of the usage. Please follow Local Ordinances or Regulations for disposal.
	Keep dry
	Attention, consult accompanying documents
	Type BF Applied Part
	Stand by

### TABLE OF CONTENTS

1. GENERAL	2
- PRINCIPLE OF OPERATION	2
- NEW TECHNOLOGIES USED	2
2. IMPORTANT SAFETY INSTRUCTIONS	2
3. PREPARATION	3
- BATTERY INSTALLATION	3
- USING AN AC POWER ADAPTER	3
4. USING THE DEVICE	3
- CORRECT POSTURE	3
- APPLYING THE CUFF	4
- TAKING A MEASUREMENT	4
- IRREGULAR HEARTBEAT DETECTOR	4
- WHO CLASSIFICATION INDICATION	4
5. ERROR AND LOW BATTERY INFORMATION	4
6. TROUBLESHOOTING	5
7. CARE, STORING, REPAIR AND RECYCLING	5
8. SPECIFICATIONS	5
9. MANUFACTURER'S DECLARATION	5
10. QUALITY GUARANTEE	6
11. REQUIRING RECORD	6
12. PERIODIC SAFETY CHECKS	6

### GENERAL

This instruction manual is intended to assist the user with safe and efficient operation of the automatic digital blood pressure monitor (hereinafter: device) model iBloodPressure. The device must be used in accordance with the procedures described in this manual. It is important to read and understand the entire manual, especially the section < **IMPORTANT SAFETY INSTRUCTIONS** >. This device is intended for the non-invasive measurement of systolic and diastolic arterial blood pressure and pulse rate in adults and children 15 years old and above.

#### CAUTION:

1. Do not use this device on infants or persons who cannot express their intentions.
2. The device is not suitable for measuring the blood pressure of children under 15 years of age.
3. People who suffer from arrhythmia, cardiovascular problems or who have had a stroke should consult their doctor before using the device.

#### PRINCIPLE OF OPERATION

This device adopts the oscillometric technology with Fuzzy Algorithm to measure the arterial blood pressure and pulse rate. The cuff is wrapped around the arm and automatically inflated by the air pump. The sensor of the device catches weak fluctuation of the pressure in the cuff produced by extension and contraction of the artery of the arm in response to each heartbeat. The amplitude of the pressure waves is measured, converted to millimeters of the mercury, and is displayed by a digital value.

**ATTENTION:** This device can not provide reasonable accuracy if used or stored in the temperature, humidity or altitude beyond the range stated in the section <SPECIFICATIONS> of this manual.

#### NEW TECHNOLOGIES USED

Fuzzy Algorithm is the processing algorithm, taking into account the specialty of individual heartbeats, which provides higher accuracy of measurement. Software version: V1.1

### IMPORTANT SAFETY INSTRUCTIONS

It is necessary to know that arterial blood pressure is subjected to fluctuations. The level of the arterial blood pressure depends on many factors. Generally arterial blood pressure is lower in summer and higher in winter. Arterial blood pressure changes with atmospheric pressure and is affected considerably by many factors, medications, drinking, and smoking can greatly affect the level of an individual's blood pressure. Blood pressure does vary with age.

Please read the instruction manual carefully before using this device, especially < Important safety instructions >, it can help you use the device correctly and safely!

Please keep the instruction manual for future use. For specific information about your own blood pressure, consult your physician.

#### Warnings

- Consult your physician before use if you have an electrical implant.
- If you had a mastectomy do not use this blood pressure monitor on the arm on the side of the mastectomy.
- Pregnant women should only measure their own blood pressure in consultation with their doctor, since the readings may be affected by pregnancy.
- Do not service or maintain the cuff while in use.
- Do not use this blood pressure monitor on any arm where intravascular access or therapy (such as an intravenous drip or a blood transfusion), or an arteriovenous shunt (A-V shunt) is present. The temporary interference to blood flow by the blood pressure measurement could result in injury.
- Do not use the device with other medical electrical (ME) equipment simultaneously.
- Do not use the device in the area the HF surgical equipment, MRI, or CT scanner exists, or in the oxygen rich environment.
- Do not use a mobile phone or other devices that emit electromagnetic fields, near the device. This may result in incorrect operation of the device.
- Never use any accessories or parts from other manufacturers. Using such accessories or parts could cause a hazardous situation for the user or damage to the device.
- Do not modify this equipment without authorization of the manufacturer.
- The batteries used in this device may present a fire or chemical burn hazard if mistreated. Do not disassemble, heat or incinerate.
- Keep equipment away from fire and heat sources to prevent fire or explosion
- Please keep the unit out of reach of infants, children under 15 or pets, since inhalation or swallowing of small parts can be dangerous or even fatal.
- The continuous cuff pressure may cause harmful injury if the tubing has kinks.
- Do not use an extension cord with this device.
- Keep out of reach of children under 15.
- Do not put the air tube around your neck - this may result in suffocation!
- A device should never be left unattended when plugged in.
- Do not reach for a corded device that has fallen into water. Unplug immediately.
- It is quite normal that two measurements taken in quick succession may produce significantly different results, because too frequent and consecutive measurements could cause disturbances in blood circulation and injuries.

#### Cautions

- Use this device under the right environmental conditions as indicated in this user manual. If not, this could affect the performance, lifetime of the device and measurement results.
- Only use this device for its intended purpose as described in this user manual.
- Do not confuse self-monitoring with self-diagnosis. This device allows you to monitor your blood pressure. Do not begin or end medical treatment based on the measurement results. Always consult your physician for treatment advice.
- Do not take any therapeutic measures on the basis of a self-measurement. Never change prescribed medication without consulting your physician. Consult your physician if you have any questions about your blood pressure.
- If you are taking medication, consult your physician to determine the most appropriate time to measure your blood pressure.
- Consult the physician if measurement errors occur in children or persons with arrhythmia.
- The pulse display is not suitable for monitoring the frequency of cardiac pacemakers.
- Common arrhythmias (such as atrial or ventricular premature beats or atrial fibrillation) and peripheral artery disease / arteriosclerosis can affect the accuracy of this blood pressure monitor. Please consult your physician on how to best use this blood pressure monitor if you suffer from any of these conditions. Blood pressure measurement is not suitable in cases of serious arteriosclerosis (hardening of the arteries).
- Always check the device and cuff before you use it. Do not use the device or cuff if one of them is damaged, because this may cause injury.
- This device is not intended for use on extremities other than the arm or for functions other than obtaining a blood pressure measurement.
- Do not attach the cuff on the same arm on which other monitoring medical electrical equipment is attached simultaneously, because this could cause temporary loss of function of those simultaneously-used monitoring medical electrical equipment.
- Never attach the cuff on injured skin, an injured arm or an arm under medical treatment as this can cause further injury.
- Do not forcibly crease the arm cuff or the air tube excessively.
- Do not press the air tube while taking a measurement.
- Do not use the device in the case of existing polyester or nylon material allergies.
- This device is not suitable for continuous monitoring during medical emergencies or operations.

- This device cannot be used with HF (High Frequency) surgical equipment at the same time.
- This device is not washable. Never immerse the device in water and do not rinse it under the tap.
- This device should be kept dry to prevent moisture buildup.
- The equipment is not AP/APG equipment and is not suitable for use in the presence of a flammable anesthetic mixture with air, with oxygen or nitrous.
- To avoid measurement errors, do not use the device near strong electromagnetic fields, radiated interference signal or electrical fast transient/burst signal. For example magnets, radio transmitters, microwave ovens.
- If this device was stored in cold temperatures, let it sit at room temperature for at least 1 hour.
- Repeated measurements with an interval of 3 minutes are recommended, so you can calculate the average to get a more accurate measurement. An interval of 3 minutes can also ensure that the operation of the device does not result in prolonged impairment of the circulation of the blood.
- Atherosclerosis patients may require longer intervals (10-15minutes) as elasticity of patient's blood vessels decreases significantly with the disease. 10-15 minute intervals are also recommended for patients who have been living with diabetes for a long period of time.
- Dispose of the device, components and optional accessories according to applicable local regulations. Unlawful disposal may cause environmental pollution.

#### CLASSIFICATION

- ME EQUIPMENT not intended for use in an oxygen rich environment or in the presence of flammable mixers.
- Internally powered equipment (without adapter), Class II equipment (with adapter).
- Type BF applied part, recognize the cuff as applied part.

### BATTERY INSTALLATION

1. Open the battery cover and install four 'AA' type batteries into the battery compartment as indicated. Make sure that the polarity is correct;
  2. Close the battery compartment cover.
- Replace the batteries when the replacement indication " " appears in the display or nothing happens after the " " button is pressed;
  - Use AA alkaline batteries, do not use rechargeable batteries;
  - Only the same type of batteries should be used together;
  - Replace all batteries simultaneously;
  - If the device is to be unused for a long time, please take out the batteries;
  - Don't leave the worn batteries in the device.

### USING AN AC ADAPTER

Besides batteries you can use an AC adapter as the power supply. The AC adapter is optional for this device and is sold separately.

The AC adapter is specified as a part of the blood pressure monitor.

- Insert the AC adapter cord into the jack on the right side of the monitor
- Insert the AC adapter plug into the outlet.
- To remove the AC adapter, disconnect the adapter plug from the AC outlet first and then disconnect the cord from the monitor's jack.

#### Caution

- When using optional AC adapter, the AC adapter must comply with the requirements of standard IEC60601-1.
- To avoid possible damage of the monitor, use only the exclusive AC adapter that can be purchased from authorized dealers. Other adapters may damage the blood pressure monitor.
- The AC adapter is used as an isolating means, the AC adapter plug shall insert into the outlet nearby the operator, making it easy to disconnect the device from the outlet.
- If you have been using the device for a long time, let the adapter cool before removing the plug to prevent burns.
- Plug the AC adapter into the appropriate voltage outlet. Do not use in a multi-outlet plug.
- Do not position the blood pressure monitor so that is difficult to disconnect the adapter.

**Note: The monitor is designed not to draw power from the batteries when the AC adapter is in use.**

Optional AC adapter technical features:

Model: YS5M-0600600  
Input: 100-240V 50/60Hz  
Output voltage: 6V±5%  
Output current: 600 mA



### USING THE DEVICE

The iBloodPressure digital blood pressure monitors have built-in SIM cards that can transmit data to your care team.

- After the device is powered on, it will enter the automatic time update function first as shown in Fig. 1.
- After the time is updated, the standby screen is displayed as shown in Fig. 2.
- If you don't want to update the time, press the button " " to exit and enter standby mode or turn off the device.

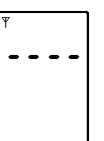

Fig.1

#### Caution:

- Please keep quiet for 5-10 minutes and avoid eating, drinking, alcohol, smoking, exercising and bathing before taking a measurement. All these factors may influence the measurement result.
- Remove any garment that fits closely to your upper arm.
- Always measure on the same arm (normally left).
- Measurements should be taken regularly at the same time of each day, as blood pressure varies throughout the day.
- Any effort to support the arm during measurement may increase the measured blood pressure.
- Make sure you are in a comfortable, relaxed position with uncrossed legs, feet flat on the floor, back and arm supported, middle of the cuff at the level of the right atrium of the heart and do not move or constrict your muscles or talk during measurement. Use a cushion to support your arm if necessary. Maintain this position for the entire measurement.
- If the arm artery lies lower or higher than the heart, a false reading may be obtained.
- A loose or open cuff may cause false readings.
- With repeated measurements, blood accumulates in the arm which can lead to false readings.
- Consecutive blood pressure measurements should be repeated after a 3 minute pause or after the arm has been held up in order to allow the accumulated blood to flow away.

### CORRECT POSTURE

1. Sit at a table and let the table support your arm as you take the measurement.
2. Sit upright with your back straight.
3. Make sure that the cuff on the upper arm and is at approximately the same level as the heart.
4. Make sure your feet are flat on the ground and are not crossed.
5. You may lie on your back and take a measurement. Look at the ceiling, keep calm, and don't move your neck or body during the measurement.

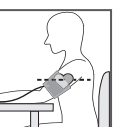



## APPLYING THE CUFF

1. Insert the edge of the cuff approximately 5 centimeters into the D-ring as shown.
2. Put the cuff on the left upper arm with the tube pointing to the direction of palm. If measuring on your left arm is difficult, you can use your right arm for measurement. In this case, it is necessary to know that the readings may differ about 5-10 mmHg between your left arm and right arm.
3. Wrap the cuff around your upper arm with the lower edge of the cuff approximately 1 inch above the elbow. The mark <ARTERY> must be over the artery of the arm.
4. Press the cuff to make sure that it is attached securely. The cuff should not be too tight or loose. The cuff should be tight while still being able to easily fit two fingers between the cuff and your arm.
5. The mark <INDEX> on the cuff must point to area <NORMAL>. This means the cuff size is correct. If mark <INDEX> points to the area beyond area <NORMAL>, please consult your care team on whether you need another size cuff. This device is supplied with the universal cuff range between 8.66-16.54 inch.
6. Sometimes it is difficult to make the cuff lay flat depending on the shape of the user's upper arm, the cone-shape assembly of cuff is also acceptable.
7. If your clothes restrict the blood circulation of your upper arm, or you roll your sleeve up so as to result in such restriction, please take off your shirt to get an accurate measurement if necessary.



### Caution:

If you experience discomfort during a measurement, such as pain in the upper arm or other complaints, press the 'U' button to release the air immediately from the cuff. Loosen the cuff and remove it from your arm.

## TAKING A MEASUREMENT

1. Insert the tube plug into the air connector. Before the measurement, take 3-5 deep breaths and relax your body. Don't talk or move your arm;
2. Press the 'U' button, and all symbols will appear on the display in 2 seconds as shown in Fig 2. The cuff will begin to inflate with the display showing the reading of the pressure as shown in Fig 3;
3. The pressure in the cuff will increase to working pressure. Then the pump stops and pressure falls quickly, during which the user's blood pressure and pulse will be calculated as shown in Fig 4;
4. After the measurement, the systolic pressure, diastolic pressure, and pulse rate will show in the display as shown in Fig 5. At the same time, the 'Sending' icon is displayed, indicating that data is being uploaded;
5. The time of measurement will also be displayed. The time is automatically synchronized during data upload.
6. When the 'Sending Done' icon is displayed as shown in Fig 6, the data transmission is successful. When the 'Sending Failed' icon is displayed as shown in Fig 7, the data transmission has failed.
7. If you don't want to transmit data, press the button 'U' to turn off the device. Please rest for at least 3 minutes for another measurement. If the power supply is not switched off and the device remains unused for 3 minutes, the device will be switched off automatically.

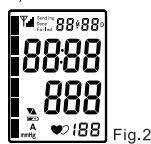

Fig.2

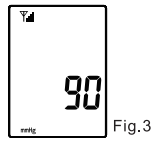

Fig.3

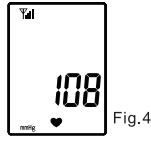

Fig.4



Fig.5



Fig.6



Fig.7

### Caution:

The measurement results are saved only when the transmission fails or the data is forced to be transmitted. After the measurement data is transmitted, the machine will automatically detect the stored memory data. If there is any memory data that has not been transmitted, it will send the data that has not been transmitted first.

### RAPID DEFLATION DURING MEASUREMENT

If you do not feel well during measurement or want to stop the measurement for some reason, you can press the "U" button. The device will quickly release the air in cuff and the device will be returned to standby mode.

## IRREGULAR HEARTBEAT DETECTOR

The iBloodPressure digital blood pressure monitor provides a blood pressure and pulse rate measurement even when an irregular heartbeat occurs. When the device detects the irregular heartbeat or any excessive body movement during measurement, the '♥' icon will display in the LCD as shown in Fig 8. It is important that you are relaxed, remain still and do not talk during measurement.

Notice: We recommend contacting your physician if you see this '♥' indicator frequently.



Fig.8

## WHO CLASSIFICATION INDICATION

Standards for assessment of high or low blood pressure, regardless of age, have been established by World Health Organization (WHO) as show in the chart as below:

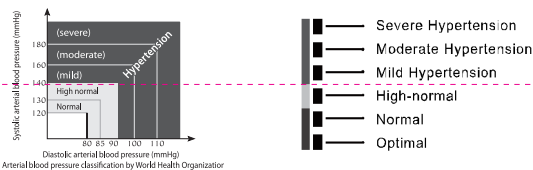

The chart displays classifications, based on current data, corresponding to the WHO classifications.

For example, if your blood pressure is 145mmHg (systolic pressure), 88mmHg (diastolic pressure), according to the World Health Organization standard, your blood pressure level is Mild Hypertension.

Note: If the systolic blood pressure and the diastolic blood pressure fall into different categories, the higher value should be taken for classification.

## ERROR AND LOW BATTERY INFORMATION

INDICATION	POSSIBLE REASON	CORRECTION METHODS
	The cuff is put on incorrectly or the tube plug is inserted too loosely. Movement of arm/hand talking during measurement. The cuff is not inflated to necessary pressure.	Make sure that cuff is put on correctly and the tube plug is inserted tightly and repeat the measurement. Repeat the measurement while closely following the recommendations outlined in this manual.
	The batteries are weak	Replace all 4 batteries with new ones.

## TROUBLESHOOTING

SYMPTOM	CHECK POINT	REMEDY
No display when the device is powered on.	The batteries have run down. The polarity of the batteries is wrong. The contact of the battery compartment is polluted.	Replace all the batteries with new ones. Install the batteries correctly. Clean the battery terminals with dry cloth.
Inflation stops and reinflates later.	The automatic inflation feature for ensuring correct measurement. Did you talk or move your arm (or hand) during measurement?	Keep quiet and silent during the measurement.
The reading is extremely low or high.	Is the cuff at the same level as the heart? Is the cuff wrapped correctly? Did you strain your arm during measurement? Did you talk or move your arm (or hand) during measurement?	Make sure that your posture is right. Wrap the cuff correctly. Relax during measurement. Keep quiet and silent during the measurement.
Pulse rate is too low or too high.	Did you talk or move your arm (or hand) during measurement? Did you make measurement right after exercise?	Keep quiet and silent during the measurement. Take measurement again after resting for more than 5 minutes.
The batteries run out quickly.	Faulty batteries are used.	Use alkaline batteries of known manufacturers.

## CARE, STORING, REPAIR AND RECYCLING

1. It's necessary to protect this device against high moisture, direct sunlight, shock, solvent, alcohol and gasoline.
  2. Remove the batteries if the device is being stored for a long time, and keep the batteries far away from children.
  3. Keep the cuff away from sharp objects and don't extend or twist the cuff.
  4. This device is not washable. Never immerse the device in water and do not rinse it under the tap.
  5. Do not clean or perform maintenance on the device when it is in use with a patient.
  6. The cuff is sensitive and must be handled with care. You can clean the cuff with a damp cloth for daily maintenance.  
To avoid cross infection when sharing the cuff, you can sterilize the fabric cover of the cuff with cotton balls moistened by 3% solution of hydrogen dioxide. After prolonged use there will be a partial discoloration on the fabric of the cuff. Do not launder or iron the cuff as well as ironing with a hot flatiron.
  7. Since neither the device nor batteries are household waste, follow your local recycling rules and dispose of them at an appropriate collection site.
  8. Do not open the device, or delicate electrical components such as an intricate air unit could be damaged. If you can not fix the problem using the troubleshooting instructions, please request service from your dealer.
- WARNING:** Do not repair the device without manufacturer's authorization. Do not carry out maintenance when using the device.
- Caution:** Generally, we recommend the device should be inspected every 2 years and utilize the manometer mode to verify the accuracy of the manometer at least at 50mmHg and 200mmHg after maintenance and repair. Please contact your dealer for maintenance.

## SPECIFICATIONS

Model	iBloodPressure (SMBP-LD-575-001)
Size	134(L) × 98(W) × 57(H)mm
Weight	Approximately 236g without batteries
Measuring method	Oscillometry
Measuring range	40 to 180mmHg(DIA,diastolic pressure) 60 to 260mmHg(SYS,systolic pressure) 40 to 160 beats/minute (PUL,pulse)
Measuring accuracy	± 3 mmHg for static pressure ± 5% of the reading for the pulse rate
Inflation	Automatic by the pump
Rapid deflation	Automatic electronic valve
Batteries	Optional component, 4"AA"×1.5V
Adapter	Optional component, 6V, 600mA
Operation temperature and humidity, air pressure	+10 C to + 40 C, 85% and below 800hPa to 1060hPa
Transport and storage temperature and humidity, air pressure	-20 C to + 50 C, 85% and below 500hPa to 1060hPa
Upper arm circumference	Applicable for arm circumference 8.66-16.54 inch. (Universal cuff)
Complete kit	Main body, cuff, 4×AA batteries (optional), adapter (optional), gift box, instruction manual
Overvoltage category	Category II



**HONSUN (NANTONG) Co., Ltd.**

Add: No.8, Tongxing Road, Economic & Technical Development Area, Nantong City, Jiangsu, P.R.CHINA



**SHANGHAI INTERNATIONAL HOLDING CORP. GMBH (EUROPE)**  
Address: Eiffestrasse 80, 20537 Hamburg GERMANY

## MANUFACTURER'S DECLARATION

Compliance information for each EMC test	
Electromagnetic Emission(Home Healthcare Environment)	
<b>Emission test(IEC60601-1-2:2014)</b>	<b>Compliance</b>
Conducted and radiated RF emissions	CLSPR 11 Group 1 Class B
Harmonic emissions IEC 61000-3-2	Class A
Voltage fluctuations/flicker emissions IEC 61000-3-3	Complies

## Compliance information for each EMC test

Declaration-Electromagnetic Immunity(Home Healthcare Environment)		
Immunity test	IEC 60601 test level	Compliance level
Conducted RF IEC 61000-4-6	3V 150 kHz to 80 MHz 6V in ISM and amateur radio bands between 0.15MHz and 80MHz	3V 150 kHz to 80 MHz 6V in ISM and amateur radio bands between 0.15MHz and 80MHz
Radiated RF IEC 61000-4-3	10 V/m 80 MHz to 2.7 GHz also meet the requirement of table 9 of 60601-1-2:2014	10 V/m 80 MHz to 2.7 GHz also meet the requirement of table 9 of 60601-1-2:2014
Electrostatic discharge (ESD) IEC 61000-4-2	±8 kV contact ±2 kV,±4 kV,±8 kV,±15 kV air	±8 kV contact ±2 kV,±4 kV,±8 kV,±15 kV air
Electrical fast transient/burst IEC 61000-4-4	±2 kV for power supply lines	±2 kV for power supply lines
Surge IEC 61000-4-5	±0.5 kV,± 1 kV line(s) to lines	±0.5 kV,± 1 kV line(s) to lines

## MANUFACTURER'S DECLARATION

### Compliance information for each EMC test

Declaration-Electromagnetic Immunity(Home Healthcare Environment)		
Immunity test	IEC 60601 test level	Compliance level
Voltage dips, short interruptions and voltage variations on power supply input lines IEC 61000-4-11	0% Ur, 0.5 Cycle at 0°,45°,90°, 135°,180°, 225°, 270°, 315° 0% Ur, 1 Cycle and 70% Ur, 25/30 cycles single phase:at 0° 0% Ur,250/300 cycles	0% Ur, 0.5 Cycle at 0°,45°,90°, 135°,180°, 225°, 270°, 315° 0% Ur, 1 Cycle and 70% Ur, 25 cycles single phase:at 0° 0% Ur,250cycles
Power frequency (50/60Hz) magnetic field IEC 61000-4-8	30 A/m	30 A/m

NOTE: The EUT is the a.c. mains voltage prior to application of the test level. The following phenomenon is still fulfill the requirement of basic safety and essential performance.  
\*UT:230V ~/50Hz.The pressure of the EUT is deviation the normal value but the value is still more than 10psi when flow is 4.5l/min.  
\*\*UT:230V ~/50Hz.The EUT stop working when adding 0%UT,but the EUT can restore its normal mode automatically.

- Use of this equipment adjacent to or stacked with other equipment should be avoided because it could result in improper operation. If such use is necessary, this equipment and the other equipment should be observed to verify that they are operating normally.
- Portable RF communications equipment(including peripherals such as antenna cables and external antennas) should be used no closer than 30cm(12 inches to any part of this device, including cables specified by the manufacturer. Otherwise, degradation of the performance of this equipment could result.
- Under the test condition specified in immunity, the product can provide the basic safety and essential performance.
- If the essential performance is lost or degraded,additional measures are necessary,such as reorienting or relocating the device.

## QUALITY GUARANTEE

MODEL	
Warranty period	Two years from purchasing date
Purchasing date	
Purchasing shop	Name: _____ Telephone: _____
	Address: _____
Customer	Name: _____ Telephone: _____
	Address: _____

1. Warranty for this automatic digital blood pressure monitor is 24 months from the date of purchase. The 24 months warranty excludes the monitor cuff.
2. The warranty obligations are prescribed for by warranty certificate for buyer.
3. The addresses of organizations for guaranteed maintenance are present in the warranty certificate.

### WARNING

Do not modify this equipment without authorization of the manufacturer. All major maintenance on the device must be performed by an authorized service center or distributor. No use-serviceable parts inside, before servicing to authorized representative or manufacturer.

### DECLARATION:

When technical information for user or service personnel requirements is not in the scope of confidentiality of the Company, the Company committed to provide information disclosure in accordance with procedure, including circuit diagrams and parts lists, and other related type technology information that do not involve commercial secrets may be disclosed. Access to information channels and procedures, please contact your dealer or manufacturer.

## REQUIRING RECORD

Date	TROUBLE	SERVICE MAN
Guarantee Regulation	1. During warranty period the repair could be made at any BPM repair department. 2. The following things void the warranty: (1) Operating BPM differently from procedures or instructions of the manual. (2) The body is damaged intentionally. (3) Self-repairing or modifying the monitor construction in any way. (4) Breakdown due to corrosion of battery leakage. (5) Problem which occurs under natural calamity and other force majeure.	

## PERIODIC SAFETY CHECKS

If you use the device with a power adapter, preventive inspection and maintenance should be performed including the frequency of such maintenance.

- Every time before use, please check the adapter. If damaged, do not use.
- Please clean the prongs of adapter plug at least once a year. Too much dust on plug may cause the fire.

The manufacturer reserves the right to make technical changes without notice in the interest of progress. Prior notices will not be given in case of any amendments within this manual. The mentioned trademarks and names are owned by the corresponding companies.



MADE IN CHINA  
P575/2207/03